

B. INGGRIS

KELAS 1

DEVI NURVIANI, S.Pd



A

B

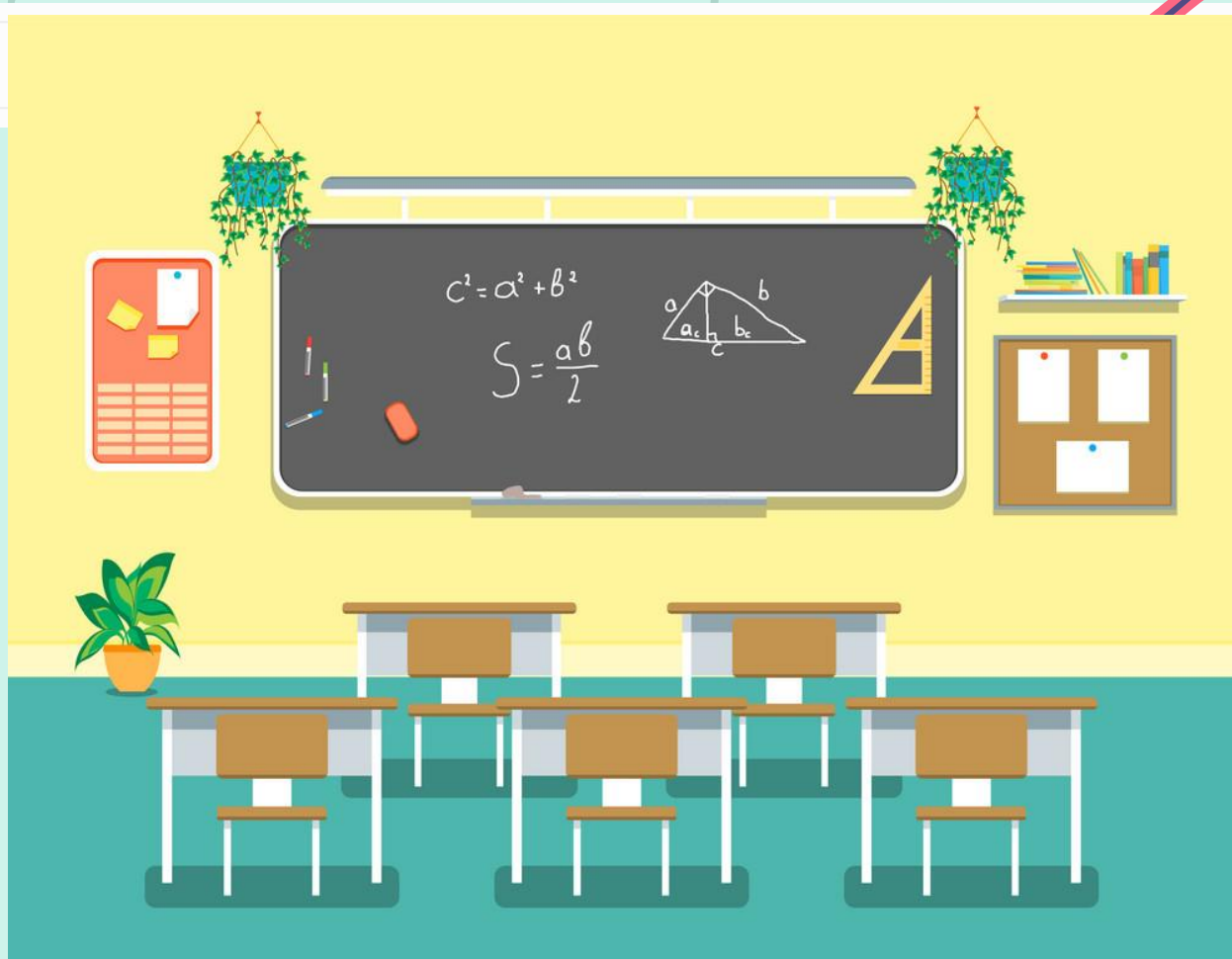

B

A

CLASSROOM OBJECTS



C

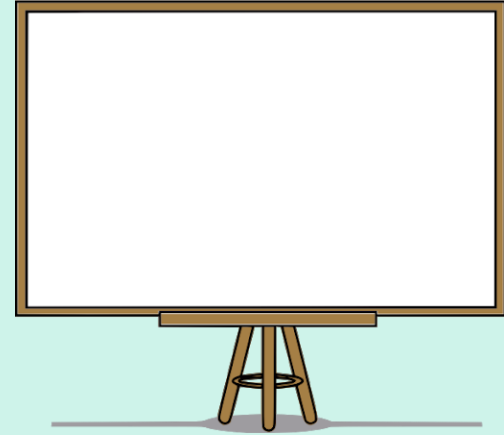

B

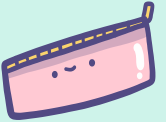

A

A

+

C



DESK



B

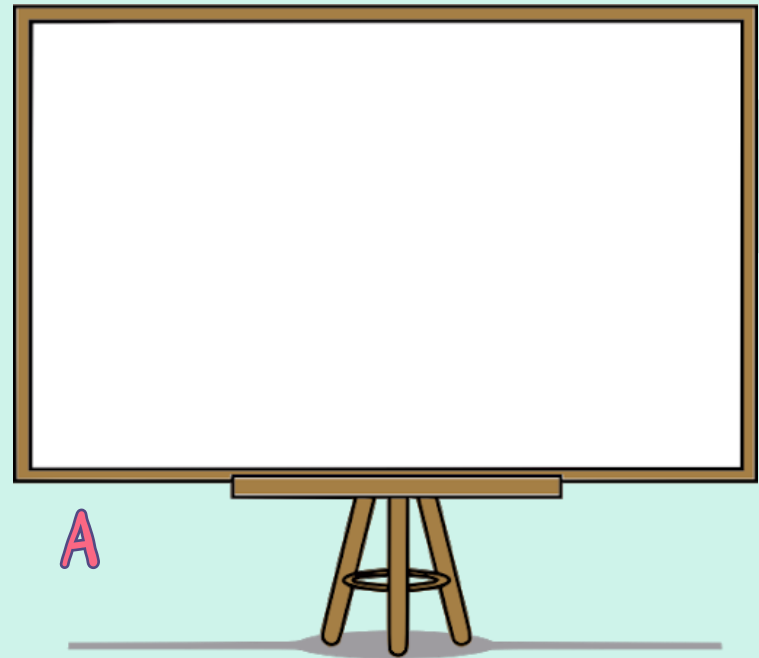

A



B

SCHOOL BAG

A



B



BOOK

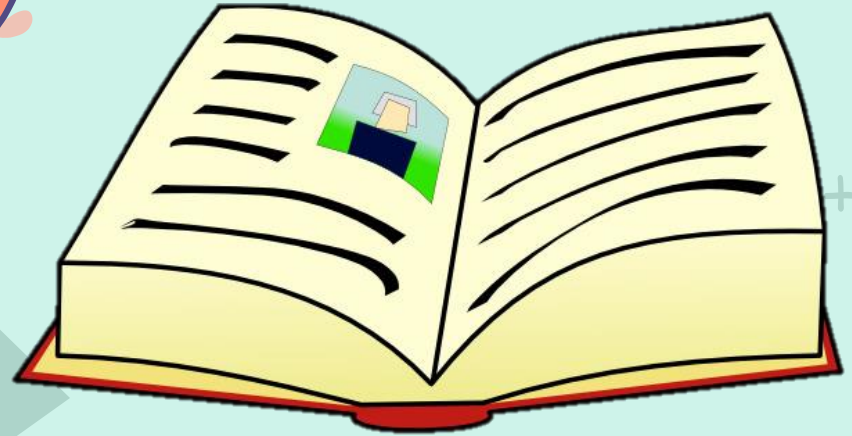

PENCIL CASE

A



B



A

+

C

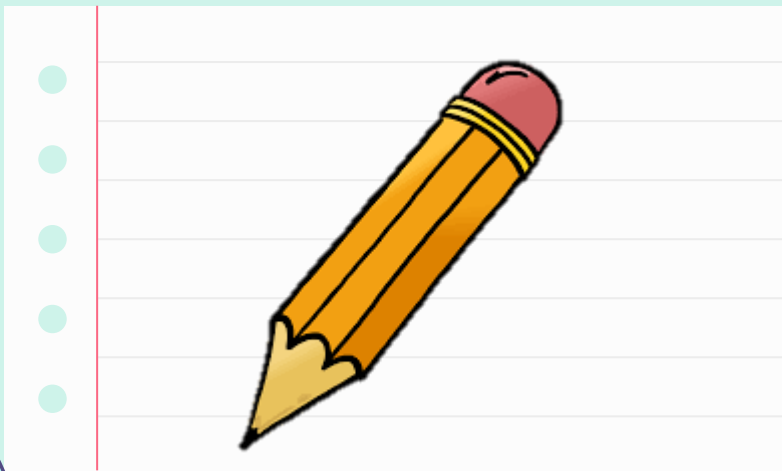

PENCIL



B

+

~

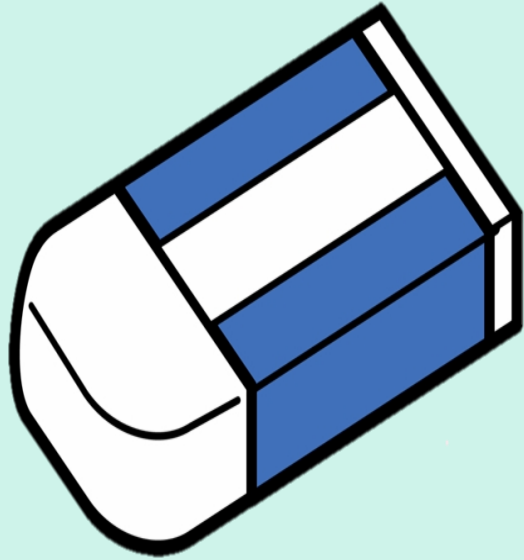

A

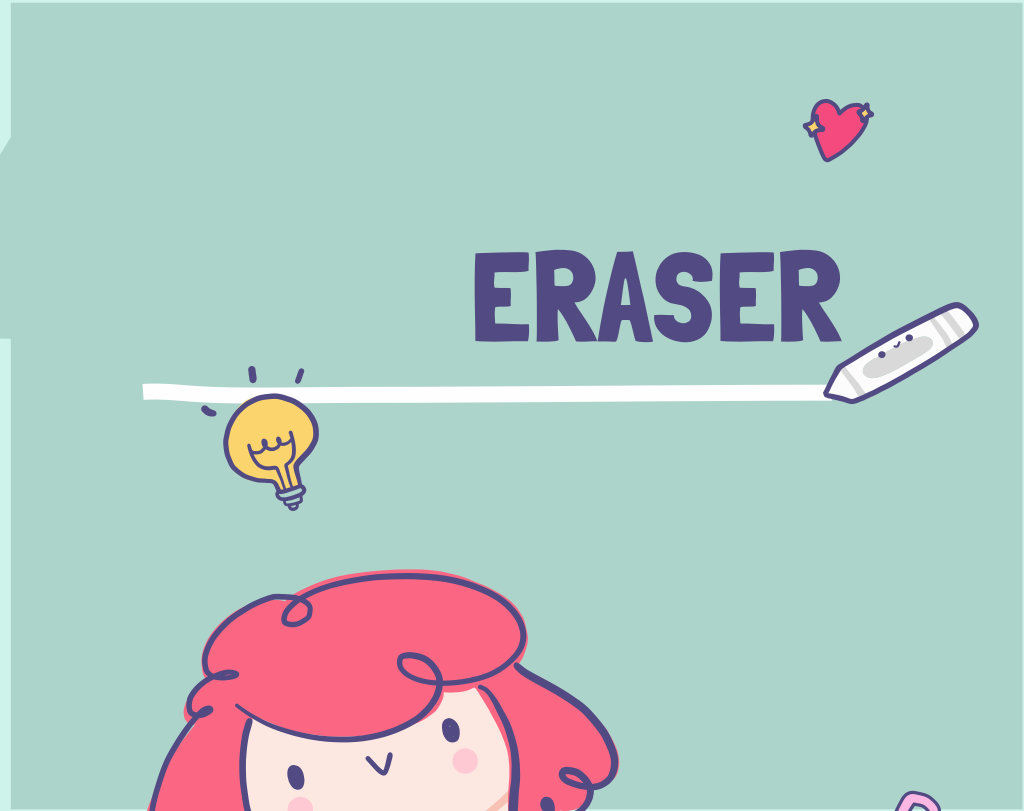

ERASER



B

A

+

C

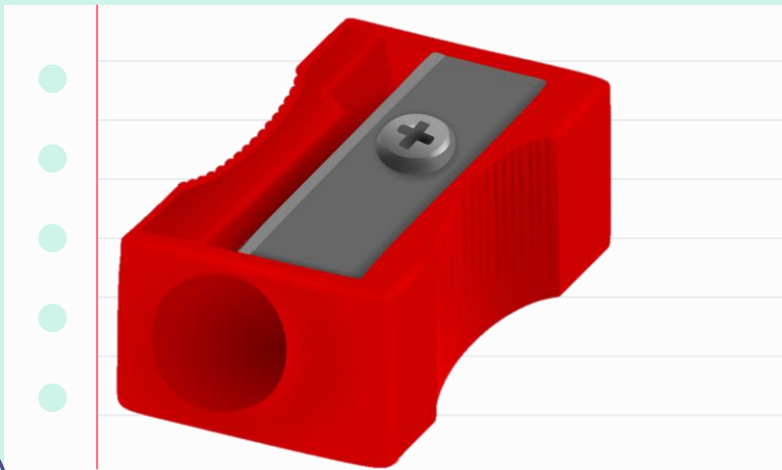

SHARPENER



B

SCISSOR



A

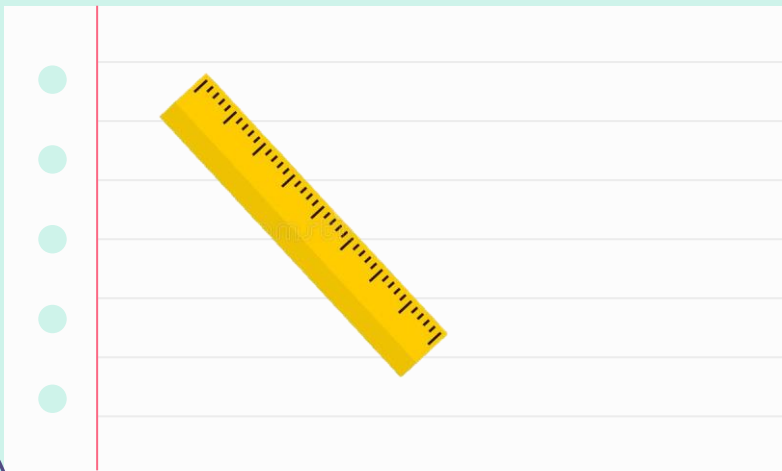

RULER



B

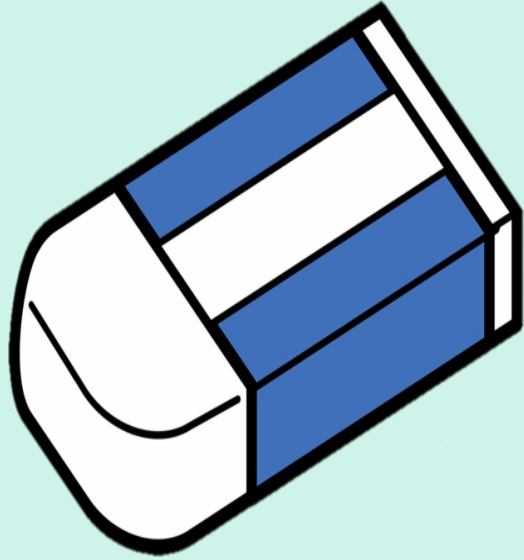

A



ER_S_R



B

A

+

C



B

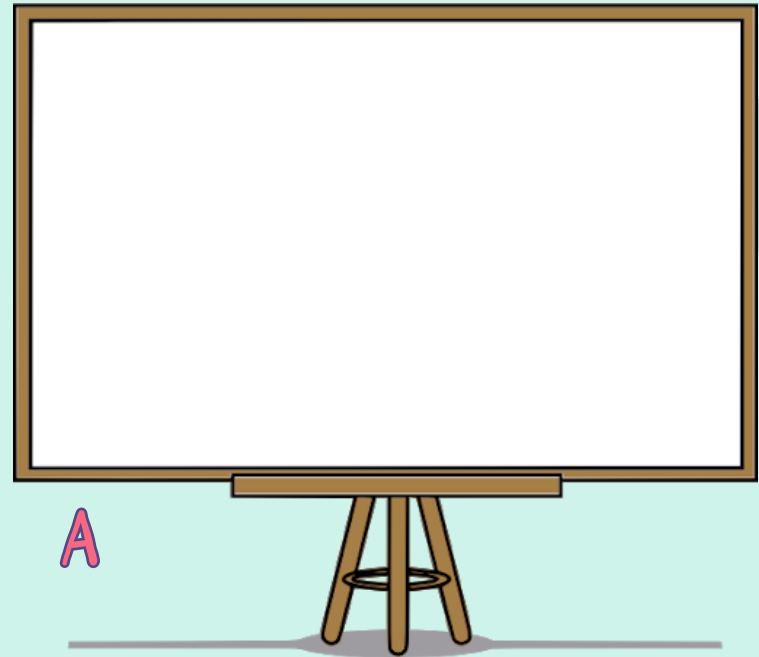

A

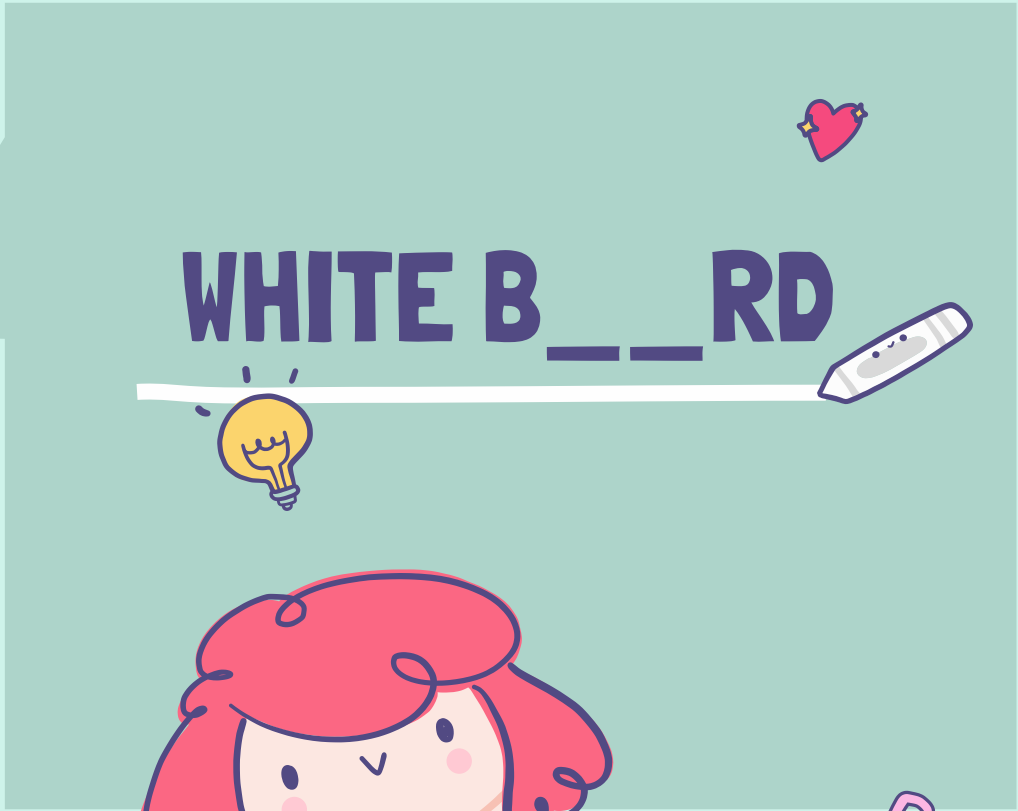

B

SCHOOL _ _ _

A

B





C

B__K

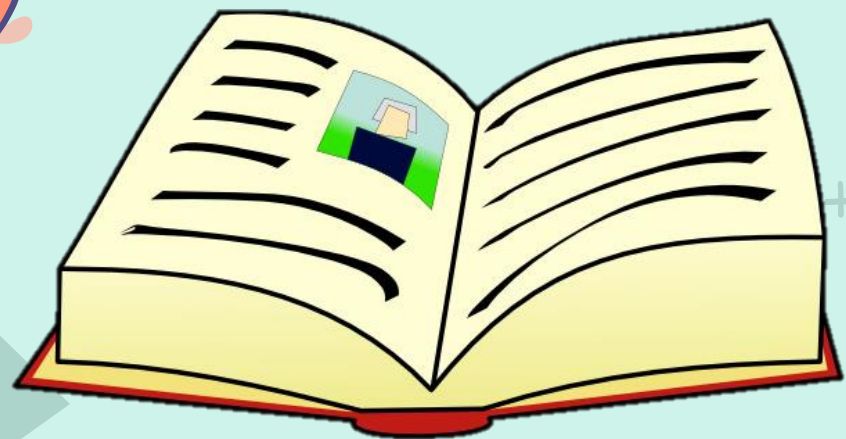

B

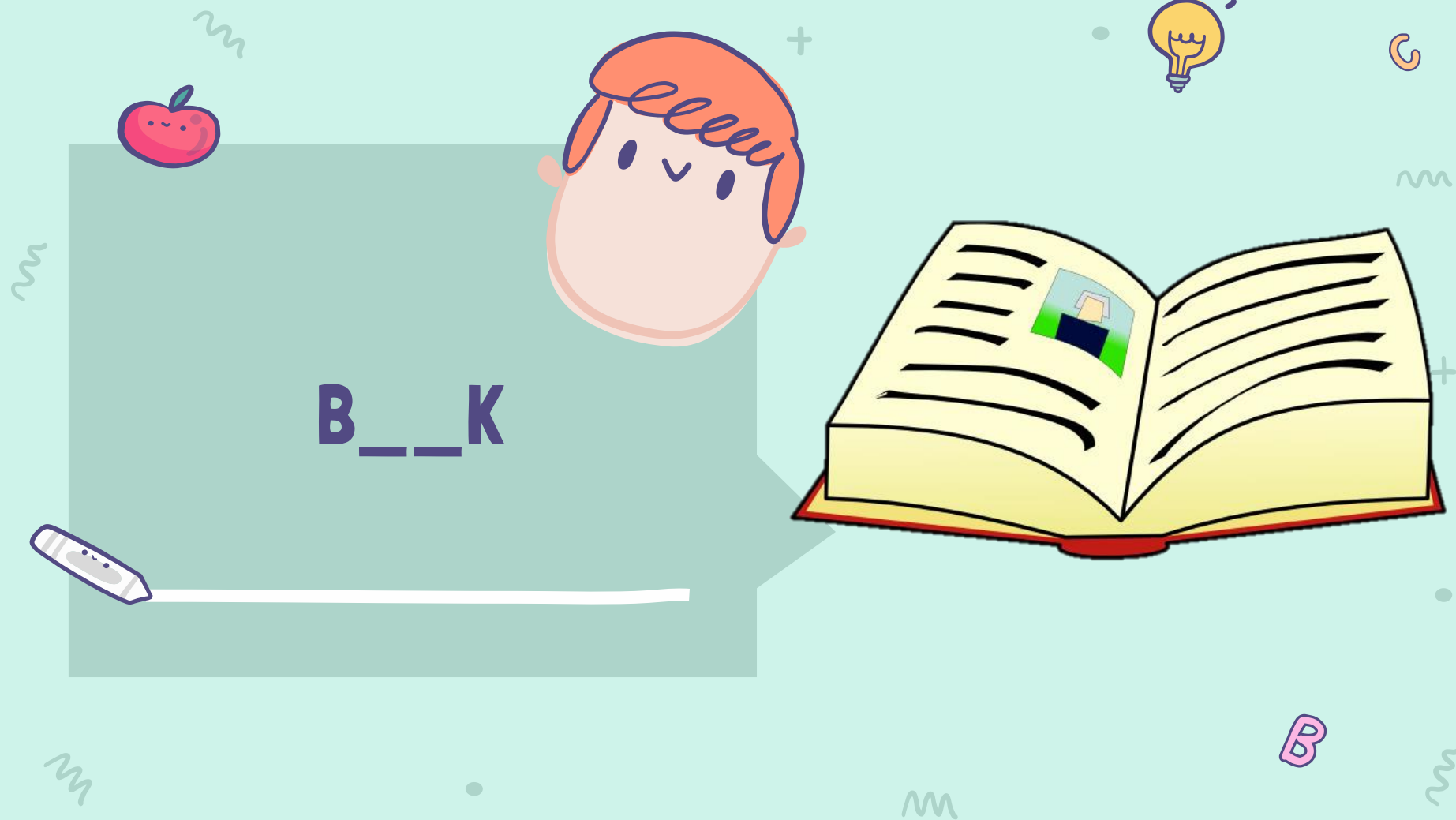

PENCIL C_S_

A

B



A

+

C

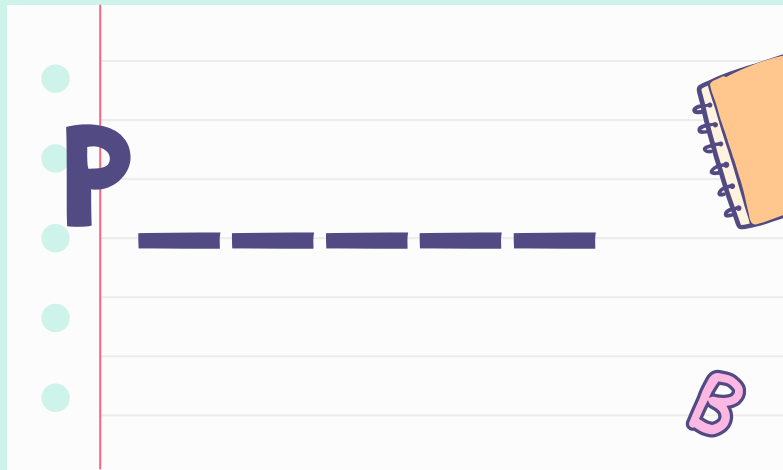
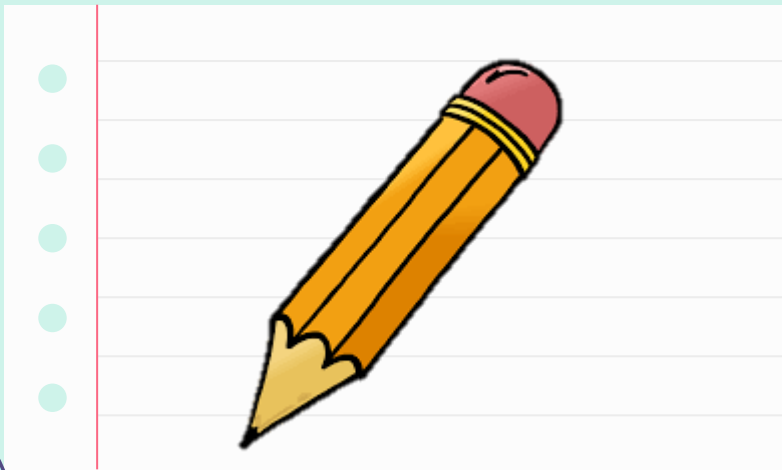

A

+

C

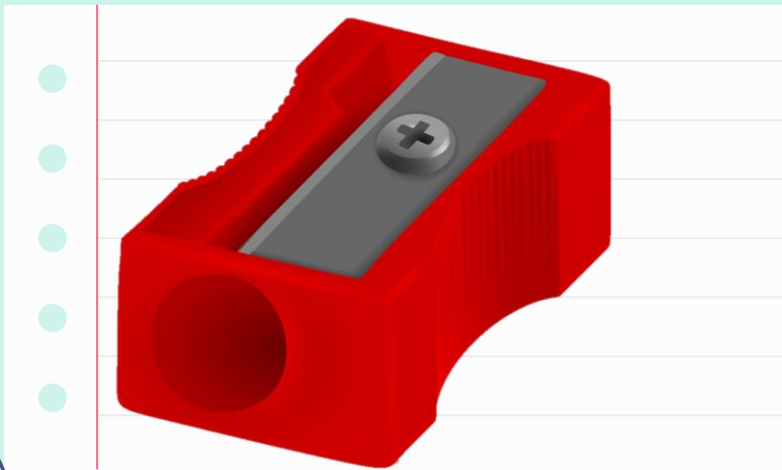

SH_RPEN_R



B

+

~



SCI__OR



B

C

+



A

+

C

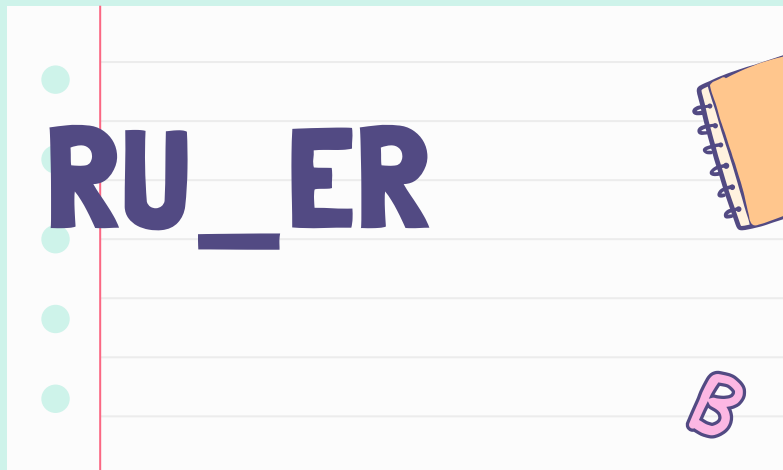
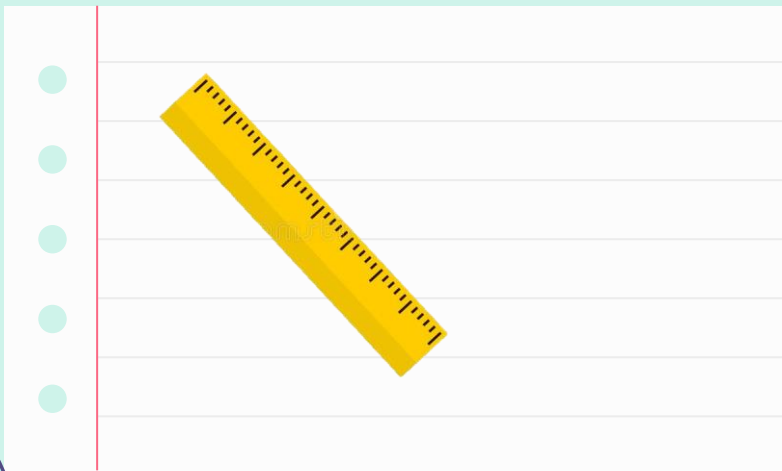

RU_ER

B

THANKYOU



A

B

C